

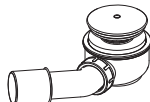

## A46-50 ▣ A46-60 ▣ A47B-50 ▣ A47B-60 A47CR-50 ▣ A47CR-60 ▣ A471CR-50 ▣ A471CR-60

[ mm ]

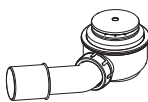

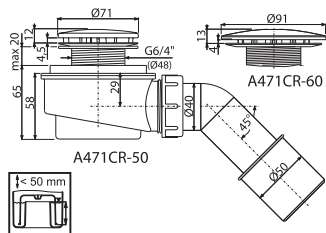
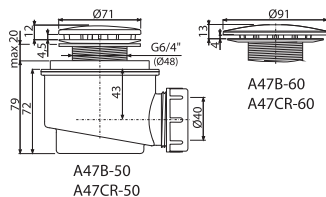
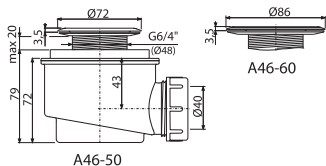
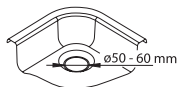
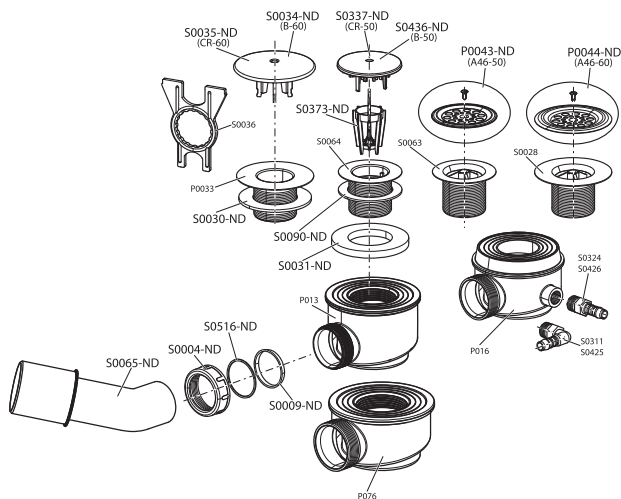

ZIRAVINA / CAUSTIC

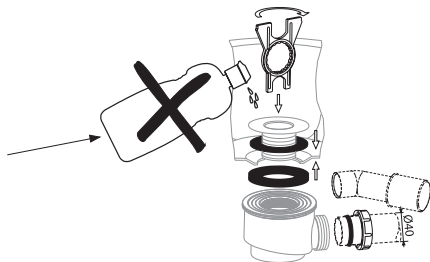

Alca plast, s. r. o.  
 Bratislavská 2846, 690 02 Břeclav, Česká republika  
 Tel.: +420 519 821 117 – prodej ČR  
 Tel.: +420 519 821 041 – export, Fax: +420 519 821 083  
 e-mail: [alcaplast@alcaplast.cz](mailto:alcaplast@alcaplast.cz), [www.alcaplast.cz](http://www.alcaplast.cz)